

KLT-L5K-IMX135 V2.0**SONY IMX135 MIPI Interface Auto Focus 13MP Camera Module**

Camera Module No.	KLT-L5K-IMX135 V2.0
Image Sensor	IMX135
EFL	3.57 mm
F.NO	2.0
Pixel	3136 x 4224
View Angle	78.4°
Lens Type	1/3.06 inch
Lens Dimensions	8.50 x 8.50 x 5.37 mm
Module Size	35.25 x 10.00 mm
Module Type	Auto Focus
Interface	MIPI

Mating Connector Part No. 24-5804-030-000-829



Mating Connector On Main Board. Sold Separately.

[Product Brief]

IMX135

Ver.1.0

Diagonal 5.867 mm (Type 1/3.06) 13M Pixel CMOS Image Sensor with Square Pixel for Color Cameras

Description

IMX135 is a diagonal 5.867 mm (Type 1/3.06) 13M pixel CMOS active pixel type stacked image sensor with a square pixel array. It adopts Exmor RS™ technology to achieve high speed image capturing by column parallel A/D converter circuits and high sensitivity and low noise image (comparing with conventional CMOS image sensor) through the backside illuminated imaging pixel structure. R, G, and B pigment primary color mosaic filter is employed. High sensitivity, low dark current and smear-free features are achieved. It equips an electronic shutter with variable integration time. It operates with three power supply voltages: analog 2.7 V, digital 1.05 V and 1.8 V for input/output interface and achieves low power consumption (comparing with CCD sensors).

In addition, this product is designed for use in cellular phone and Tablet PCs. When using this for another application, Sony does not guarantee the quality and reliability of product. Therefore, don't use this for applications other than cellular phone and Tablet PCs. Consult your Sony sales representative if you have any questions.

Functions and Features

- ◆ Back-illuminated and stacked type CMOS image sensor Exmor RS
- ◆ 2-wire serial communication circuit on chip
- ◆ CSI-2 serial data output (2Lane/4Lane selectable) on chip
- ◆ Timing generator, horizontal (H) and vertical (V) driver circuits on chip
- ◆ CDS/PGA on chip
- ◆ 10-bit A/D converter on chip
- ◆ Automatic optical black (OB) clamp circuit on chip
- ◆ High sensitivity, low dark current, no smear, excellent anti-blooming characteristics
- ◆ Variable-speed shutter function (Minimum unit: One horizontal sync signal period)
- ◆ R, G, B primary color pigment mosaic filters on chip
- ◆ Supports external mechanical shutter
- ◆ Flash control pulse generation function
- ◆ Max. 24 frame/s in all-pixel scan mode
- ◆ Pixel rate: 360 MHz (all pixels, 4Lane, 24 frame/s)
- ◆ Supports 720/60 p, 1080/30 p, 1080/60 p drive *NOTE
- ◆ Up/down and/or right/left inversed readout function
- ◆ Pixel binning readout function
- ◆ Image cutout function
- ◆ OTP ROM (One Time Programmable Read Only Memory) 8 K-bit for user, 10 K-bit as a whole
- ◆ Power-on reset function
- ◆ Image compensation processing functions (defect correction, noise reduction)
- ◆ High Dynamic Range (HDR) and tone reproduction in movie mode

NOTE) Please ask about the details of a required register.

Device Structure

- ◆ CMOS image sensor
- ◆ Image size : Diagonal 5.867 mm (Type 1/3.06)
- ◆ Total number of pixels : 4224 (H) × 3176 (V) approx. 13.42 M pixels
- ◆ Number of effective pixels : 4224 (H) × 3136 (V) approx. 13.25 M pixels
- ◆ Number of active pixels : 4208 (H) × 3120 (V) approx. 13.13 M pixels
- ◆ Chip size : 5.940 mm (H) × 4.280 mm (V)
- ◆ Unit cell size : 1.12 μm (H) × 1.12 μm (V)
- ◆ Substrate material : Silicon

Functional Description

System Outline

IMX135 is a CMOS active pixel type image sensor which adopts the Exmor RS™ technology to achieve high sensitivity, low noise, and high speed image capturing. It is embedded with backside illuminated imaging pixel, low noise analog amplifier, column parallel A/D converters which enables high speed capturing, digital amplifier, image binning circuit, timing control circuit for imaging size and frame rate, CSI2 image data high speed serial interface, PLL oscillator, and serial communication interface to control these functions.

Several additional image processing functions and peripheral circuits are also included for easy system optimization by the users.

A onetime programmable memory is embedded in the chip for storing the user data. It has 8 K-bit for users, 10 K-bit as a whole.

Overview of functional block diagram

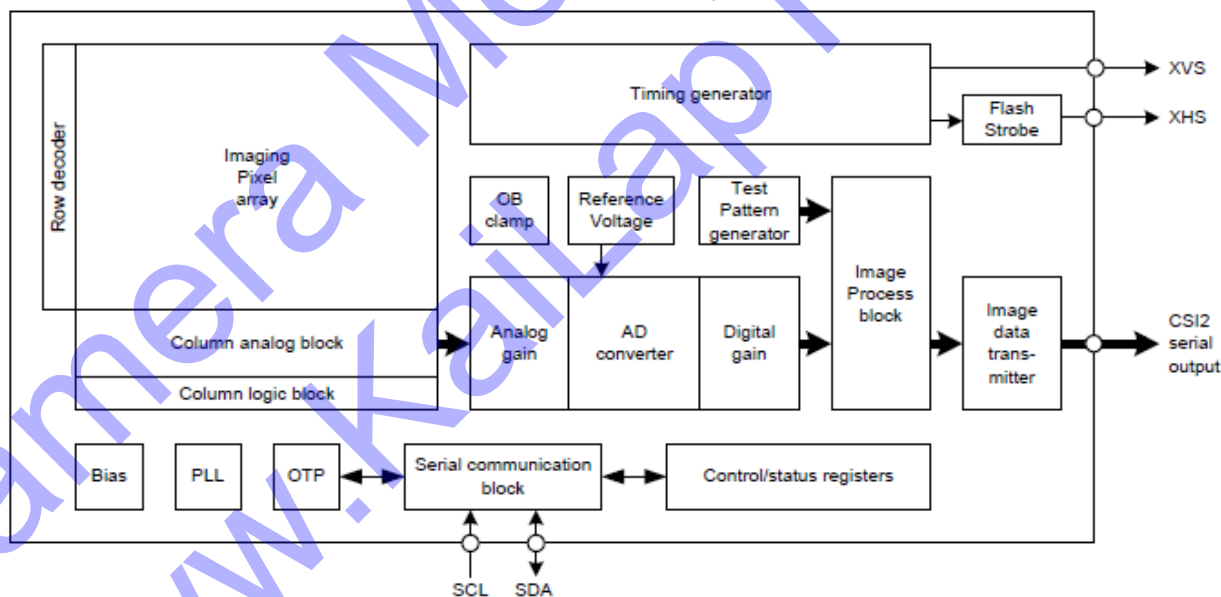

Exmor RS

* Exmor RS is a trademark of Sony Corporation. The Exmor RS is a Sony's CMOS image sensor with high-resolution, high-performance and compact size by replacing a supporting substrate in Exmor R™ which changed fundamental structure of Exmor™ pixel adopted column parallel A/D converter to back-illuminated type, with layered chips formed signal processing circuits.

Sony reserves the right to change products and specifications without prior notice.

This information does not convey any license by any implication or otherwise under any patents or other right.

Application circuits shown, if any, are typical examples illustrating the operation of the devices. Sony cannot assume responsibility for any problems arising out of the use of these circuits.